

Application Manual

Important Notice: This reference manual contains general information and data pertinent to the Nickel-metal hydride cells and batteries produced by SUPPO® Battery that are in production at the time of preparation of this manual. Since the characteristics of these products are sometimes modified, persons and businesses considering the use of SUPPO® Nickel-metal hydride products should contact SUPPO® for updated information. None of the information in this manual constitutes a representation or warranty by SUPPO® concerning the specific performance or characteristics of any of the batteries or devices. Manufacturers are encouraged to use SUPPO' consulting services to develop optimum battery designs for their application.

©2003, China Liaoning Suppo Battery (Shenyang) Co., Ltd.

Overview

The world are becoming smaller and portable electronic products are expanding rapidly to every corner of our life, digital camera, cellular phone, cordless phone, Notebook computer, Camcorder, two-way radio, MP3, portable tool.... they are becoming part of our life. With the continuing miniaturization of electronics, the ability to design ever smaller and more portable equipment is growing, this require smaller and lighter batteries with higher energy density performance.

Nickel metal hydride (NiMH) technology has been used commercially since early 1990s, since Nickel Cadmium which has been used for a long history and NiMH systems employed 1.2V nominal voltage, same size and also share many performance characteristics--it was relatively easy to adapt NiCd applications for use with NiMH.

Comparison of NiMH and NiCd Cells

Nickel-metal hydride cells are essentially an extension of the proven sealed nickel-cadmium cell technology with the substitution of a hydrogen-absorbing negative electrode for the cadmium-based electrode. While this substitution increases the cell electrical capacity (measured in ampere-hours) for a given weight and volume and eliminates the cadmium which raises toxicity concerns, the remainder of the nickel-metal hydride cell is quite similar to the nickel-cadmium product.

Many application parameters are little changes between the two cell types, and replacement of nickel-cadmium cells in a battery with nickel-metal hydride cells usually involves few significant design issues. Table 1 compares key design features between the two cell chemistries.

Table 1. Summary comparison of Nickel-Metal Hydride Application Features.

Application Feature	Comparison of Nickel-Metal Hydride to Nickel-Cadmium Batteries
Nominal Voltage	Same (1.25V)
Discharge Capacity	NiMH up to 100-200% greater than NiCd
Discharge profile	Equivalent
Discharge Cutoff Voltages	Equivalent
High Rate Discharge Capacity	Effectively the same, with the new development of NiMH, NiMH can handle over 10C discharge current, which actually double the current NiCd can handle
High Temperature (>35°C) Discharge Capacity	NiMH slightly better than standard NiCd cells.
Charging process	Generally similar: Multiple-step constant current with overcharge control required for fast charging NiMH.
Charge Termination Techniques	Generally similar, NiMH transitions are more subtle, normally rapid charge adopt at least two of $-\Delta V$, TCO and dT/dt (temperature increment) as mandatory, timer as

	backup.
Operating Temperature Limits	Equivalent
Self-Discharge Rate	NiMH is slightly higher than NiCd.
High temperature Charging efficiency	Effectively the same, High temperature NiMH is a new development
Cycle Life	Generally similar, but NiMH is more application/charging control dependent.
Mechanical Fit	Equivalent.
Mechanical Properties	Equivalent
Selection of Size/Shape/Capacities	Equivalent
Handling Issues	Similar.
Environmental Issues	Reduced with NiMH because of eliminations of cadmium of toxicity concerns.

Meeting the need of diversified application

It is not practical to have universal NiMH technology—a single battery that caters to the needs of all applications. Instead, individual NiMH batteries are designed for specific purposes. These include high-temperature, high capacity, high drain, low-temperature, electric vehicle applications etc., in addition to general-purpose needs. In order to fit the various devices, NiMH batteries come in a wide range of shapes—including cylindrical, prismatic and button varieties.

NiMH Electrochemistry

The electrochemistry of the nickel-metal hydride cell is generally represented by the following charge and discharge reactions:

Charge:

At the negative electrode, in the presence of the alloy and with an electrical potential applied, the water in the electrolyte is decomposed into hydrogen atoms, which are absorbed into the alloy, and hydroxyl ions as indicated below.

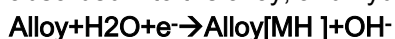

At the positive electrode, the charge reaction is based on the oxidation of nickel hydroxide just as it is in the nickel-cadmium couple.



Discharge:

At the negative electrode the hydrogen is desorbed and combines with a hydroxyl ion to form water while also contributing an electron to the circuit.

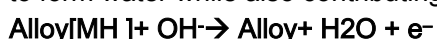

At the positive electrode, nickel oxyhydroxide is reduced to its lower valence state, nickel hydroxide.

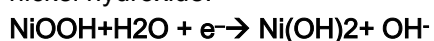

In the equations above, M represents the hydrogen—storage alloy. MH is formed

when hydrogen atoms, from the electrolysis of water, are absorbed by the alloy M. Upon discharge, the hydrogen atom is released and converted back to water.

Negative Electrode

The basic concept of the nickel-metal hydride cell negative electrode emanated from research on the storage of hydrogen for use as an alternative energy source in the 1970s. Certain metallic alloys were observed to form hydrides that could capture (and release) hydrogen in volumes up to nearly a thousand times their own volume. By careful selection of the alloy constituents and proportions, the thermodynamics could be balanced to permit the absorption and release process to proceed at room temperatures and pressures.

SUPPO adopt AB₅ alloy technology in its negative electrode, which normally consist of nickel, cobalt, Manganese, aluminum, and rare earth metal: lanthanum, cerium, praseodymium, neodymium. Different composition and manufacturing process are used to meet the requirements of different application NiMH batteries.

Positive electrode

The nickel-metal hydride positive electrode design draws heavily on experience with nickel-cadmium electrode. Nickel Hydroxide are pasted or melted onto the substrate, the balance between the positive and negative electrodes is adjusted so that the cell is always positive limited, this means that the negative electrode possesses a greater capacity than the positive. The positive will reach full capacity first as the cell is charged. It then will generate oxygen gas that diffuses to the negative electrode where it is recombined.

Cell Construction

The nickel-metal hydride couple lends itself to the wound construction shown in Figure 1. The basic components consist of the positive and negative electrodes insulated by separators. The sandwiched electrodes are wound together and inserted into a metallic can that is sealed after injection of a small amount of electrolyte.

Structure of Nickel-Metal Hydride Batteries

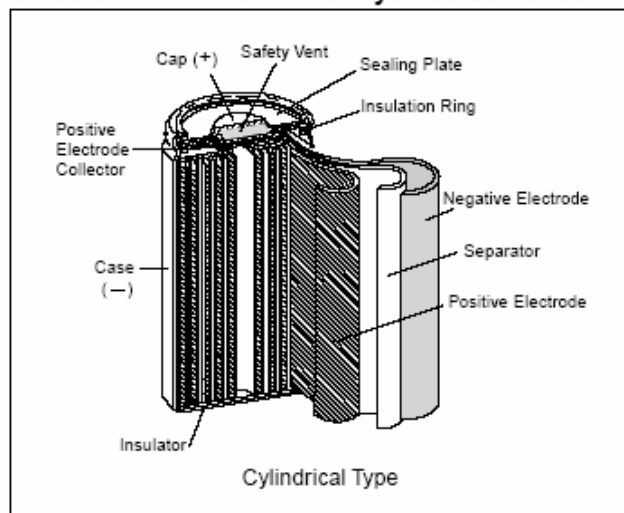

Figure 1

In a variation of this design, nickel-metal hydride cells are also being produced in prismatic versions such as that illustrated in Figure 2.

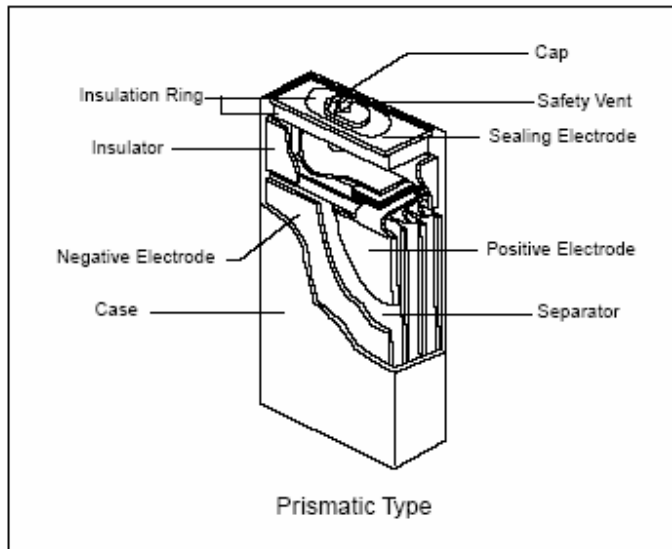

Figure 2

The general internal construction of the prismatic cell is similar to the cylindrical cell except the single positive and negative electrodes are now replaced by multiple electrodes sets

Both cylindrical and prismatic nickel-metal hydride cells are typically two-piece sealed designs with metallic cases and tops that are electrically insulated from each other. The case serves as the negative terminal for the cell while the top is the positive terminal. Normally finished cell will use a plastic/paper insulating wrapper shrunk over the case to provide electrical isolation between cells in typical battery applications.

Nickel-metal hydride cells contain a resealable safety vent built into the top. The nickel-metal hydride cell is designed so the oxygen recombination cycle described earlier is capable of recombining gases formed during overcharge under normal operating conditions, thus maintaining pressure equilibrium within the cell.

However, in cases of charger failure or improper cell/charger design for the operating environment, it is possible that oxygen, or even hydrogen, will be generated faster than it can be recombined. In such cases the safety vent will open to reduce the pressure and prevent cell rupture. The vent reseals once the pressure is relieved.

Performance Characteristics

Discharge Characteristics

The discharge behavior of the nickel-metal hydride cell is generally well-suited to the needs of today's electronic –especially those requiring a stable voltage for extended periods of operation.

Definitions of Capacity

The principal battery parameter of interest to a product designer is usually the run time available under a specified equipment use profile. While establishing actual run times in the product is vital prior to final adoption of a design, battery screening and initial design are often performed using rated capacities. Designers should thoroughly understand the conditions under which a cell rating is established and the impact of differences in rating conditions on projected performance.

The standard cell rating, often abbreviated as C, is the capacity obtained from a new, but thoroughly conditioned cell subjected to a constant-current discharge at room temperature after being optimally charged. Since cell capacity varies inversely with the discharge rate, capacity ratings depend on the discharge rate used. For nickel-metal hydride cells, the tested capacity is normally determined at a discharge rate that fully depletes the cell in five hours.

The published C value may reflect either an average or minimum value for all cells. Typically nickel-cadmium cells are rated based on minimum values while nickel-metal hydride cells are rated on average values. The difference between the two values may be significant (~10 percent) depending on the variability in the manufacturing process.

Shape of Discharge Curve

A typical discharge profile for a cell discharged at 0.2C, 1C and 3C is shown in Figure 3. At typical discharge curve of 0.2C, the initial drop from an open-circuit voltage of approximately 1.4 volts to the 1.2 volts plateau occurs rapidly. Then, as with nickel-cadmium cells, the nickel-metal hydride exhibits a sharp “knee” at the end of discharge where the voltage drops quickly. As can be seen by the flatness of the plateau and the symmetry of the curve, the mid-point voltage (MPV—the voltage when 50 percent of the available capacity is discharged) provides a useful approximation to average voltage throughout the discharge. For standard series battery, At 0.2C discharge, normally over 80% of discharge capacity can be expected over 1.2V and at 1C discharge, over 60% of discharge capacity can be expected over 1.2V.

- Discharge characteristics

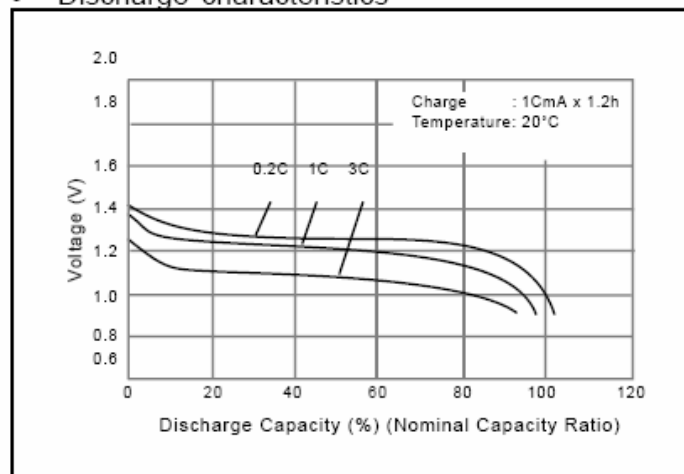

Figure 3

Capacity and Power Clarification

Though batteries are normally evaluated and tested based on capacity, the designer

should bear in mind, in heavy drain application, the application does not consumer energy but also a rated level of power from the battery, power is the value of current plus the voltage, high capacity batteries which perform a low voltage may have less run time than low capacity batteries which perform a high voltage.

There is a wrong trend of chasing high capacity in digital camera application which is power hungry usage, contrast test will tell high power but less capacity cells will take more pictures than high capacity cells.

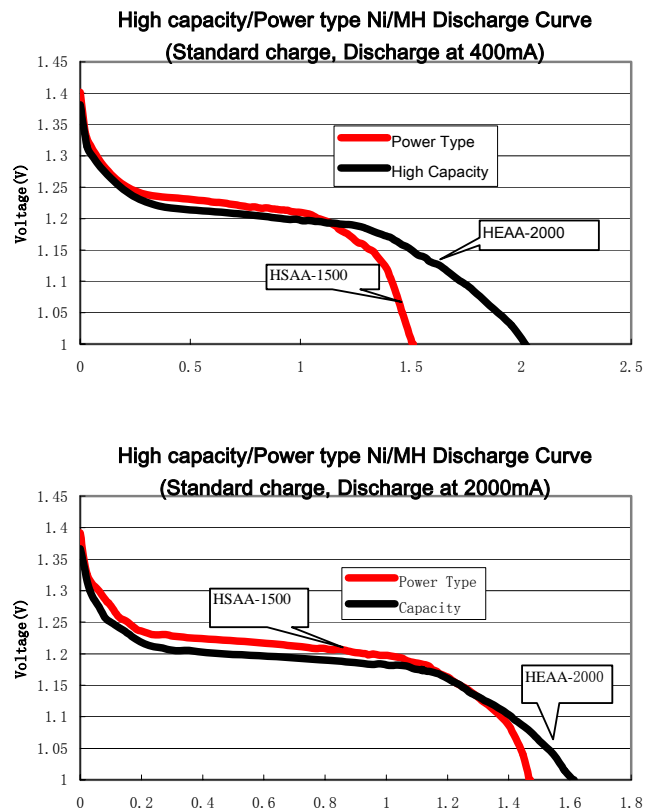

Figure 4

Discharge Capacity Behavior

The capacity available during a discharge is dramatically affected by the cell temperature during discharge and the rate of discharge. The capacity is also heavily influenced by the operating history of the cell, i.e. the recent charge/discharge/storage history of the cell. Obviously a cell can only discharge the capacity which has been returned to it from the previous charge cycle less whatever is lost to self discharge.

Effect of Temperature

The primary effects of cell temperature on dischargeable capacity, assuming adequate charging, are at lower temperatures (<0°C) as shown in Figure 5. Use of standard nickel-metal hydride cells in cold environments may result significant capacity decline from room-temperature values. SUPPO has developed special technology which allows NiMH batteries to be discharged at -20°C, please contact SUPPO for detailed specification.

- Discharge temperature characteristics at 1C discharge

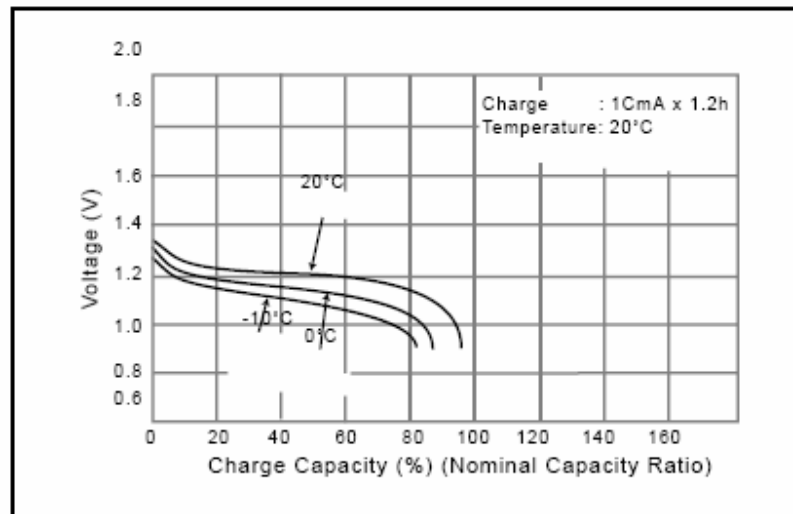

Figure 5

Effect of Discharge Rate

Figure 3 also illustrates the influence of discharge rate on total capacity available. At discharge rates above 1C to 3C, significant reductions in voltage delivery occur. This voltage reduction may also result in capacity reduction depending on the choice of discharge termination voltage

State-of Charge Measurement

A major concern for user of portable electronics is the run time left before they need to recharge their batteries. Users of portable computers, in particular, expect some form of “fuel gauge” to help them determine when they need to save their work. A variety of schemes for measuring battery state-of-charge have been suggested. In general, experience with nickel-metal hydride cells indicates that, due to the flatness of the voltage plateau under normal discharge rates, voltage sensing cannot be used to accurately determine state-of-charge.

To date, the only form of state-of-charge sensing found to consistently give reasonable results is coulometer—comparing the electrical flows during charge and discharge to indicate the capacity remaining. Many devices already have the electronics available to perform sophisticated tracking of charge flows including estimation of self-discharge losses. Some off-the-shelf charging circuitry includes this form of charge tracking as part of the package. With careful initial calibration and appropriate compensation for environmental conditions, predictions accurate within 5 to 10 percent of actual capacity can be obtained.

Discharge Termination

To prevent the potential for irreversible harm to the cell caused by cell reversal in discharge, removal of the load from the cell(s) prior to total discharge is highly recommended. The typical voltage profile for a cell carried through a total discharge involves a dual plateau voltage profile as indicated in Figure 6. The voltage plateaus

are caused by discharge of first the positive electrode and then the residual capacity in the negative. At the point both electrodes are reversed, substantial hydrogen gas evolution occurs, which may result in cell venting as well as irreversible metal hydride cell, because it uses a negative electrode that absorbs hydrogen, may actually be somewhat less susceptible to long-term damage for cell reversal than the sealed nickel-cadmium cell.

The key to avoiding harm to the cell is to terminate the discharge at the point where essentially all capacity has been obtained from the cell, but prior to reaching the second plateau where damage may occur. Two issues complicate the selection of the proper voltage for discharge termination: high-rate discharges and multiple-cell effects in batteries.

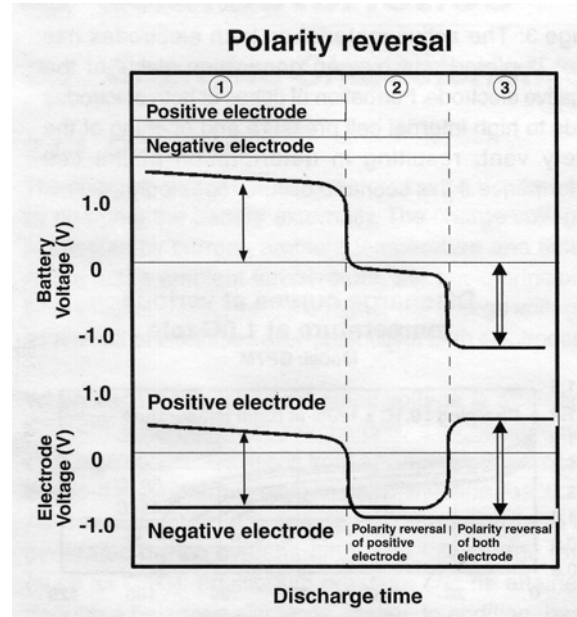

Figure 6

Voltage Cutoff at High Rates

Normally discharge cutoff is based on voltage drop to a value of 1.0 volt per cell often being used, 1.0 volt is an excellent value for most medium to long-term discharge applications (<1C). However, with high drain-rate usage (1-4C), the change in shape in the voltage curve with the more rounded "knee" to the curve means that an arbitrary 1.0v/cell cutoff may be premature, leaving a significant fraction of the cell capacity untapped. For this reason, a better choice for voltage cutoff in high-rate applications is 75 percent of the mid-point voltage at that discharge rate. Note, however, that this choice of end-of-discharge voltage (EODV) is dictated only by considerations of preventing damage to the cell. There may be end-application justification for selection of a higher voltage cutoff with the resulting sacrifice of some potential additional capacity.

Discharge Termination in Battery Packs.

Normal manufacturing variation produces a range of capacities as well as internal resistance for battery cell. As these cells are combined in batteries, the effects of cell capacity variations are amplified by the number of cells in the battery. Use of a

termination voltage based on a simple multiple of 1.0/cell times the number of cells may result in a weaker cell being driven into reverse significantly before the battery reaches the termination voltage. Both charging techniques that minimize the amount of overcharge applied to the cell and frequent repetitive discharging of the battery may exacerbate the problem. The result may be premature battery failure due to the damage caused by reversal of the weak cell. Experience indicates selection of the EODV by the following formula provides acceptable margin to minimize battery failure from repeated cell polarity reversal:

$$EODV = [(MPV - 150mV)(n - 1)] - 200mV$$

Where MPV is the single-cell mid-point voltage at the given discharge rate and n is the number of cells in the battery.

Selection of the proper discharge termination voltage, especially for large batteries or complicated application profiles, should be done in consultation with the cell manufacturer.

Charge Characteristics

Proper charging of nickel-metal hydride cells is the key to satisfaction with their performance in any product. A successful charging scheme balances the need for quick, thorough charging with the need to minimize overcharging, a key factor in prolonging cell life. In addition, a selected charging scheme should be economical and reliable in use.

In general, the nickel-metal hydride cell appears to be more sensitive to charge conditions than the nickel-cadmium cell. Especially nickel-cadmium cells are endothermic on charge while nickel-metal hydride cells are exothermic. This difference is manifested in the interrelationships among voltage, and temperature as discussed below.

Voltage, Pressure, Temperature Interrelationships

Figure 7 sketches typical behavior of a nickel-metal hydride cell being charged at the C rate. These curves both indicate why charge control is important and illustrate some of the cell characteristics used to determine when charge control should be applied.

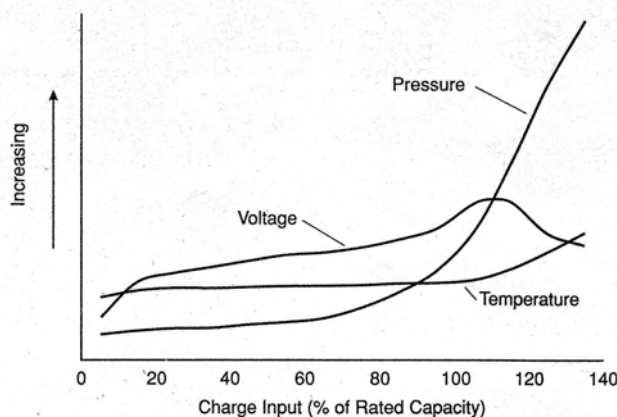

Figure 7

The voltage spikes up on initial charging then continues to rise gradually through charging until full charge is achieved. Then as the cell reaches overcharge, the voltage

peaks and then gradually trends down.

Since the charge process is exothermic, heat is being released throughout charging giving a positive slope to the temperature curve. When the cell reaches overcharge where the bulk of the electrical energy input to the cell is converted to heat, the cell temperature increases dramatically.

Cell pressure, which increases somewhat during the charge process, also rises dramatically in overcharge as greater quantities of gas regenerated at the C rate than the cell can recombine. Without a safety vent, uncontrolled charging at this rate could result in physical damage to the cell.

Overcharge Detection:

Determining when overcharge has occurred is critical to charging schemes that minimize the amount of time spent at high charge rates in overcharge. In turn, these efficient charging techniques are a key to maximizing cell life. Primary charge control schemes typically depend on sensing either the dramatic rise in cell temperature or the voltage decrement shown in Figure 7. Charge control based on temperature sensing is the most reliable approach to determining appropriate amounts of charge for the nickel-metal hydride cell. Temperature-based techniques are thus recommended over voltage-sensing control techniques for the primary charge control mechanism.

Recommend Charging Rates

Charging at around 0.5C is the best rate to ensure battery life, however, charging at 1C is most frequently required in application to rapidly recover discharged capacity, in this case, trickle charge at 0.03-0.05C is recommended after rapid is finished to counter self-discharge and maintain cell capacity.

Charging efficiency

Charging efficiency is affected by ambient temperature and charge rate. In general, it is more efficient to charge the battery at or below room temperature and relative high rate than 0.1C. As with NiCd batteries, the charging efficiency of general purpose NiMH batteries drops rapidly when the ambient temperature exceeds 40 °C . Furthermore, the decrease is more pronounced at low charging rates, since the return of electrode chemicals to their lower charge state is more evident. Recently, SUPPO has developed the technology that allows NiMH batteries to be used in those applications needing trickle charge at temperature as high as 70°C. This breakthrough technology is a result of dedicated research by SUPPO to enhance the material stability at high temperatures.

Product designers who want to mount the cells in close proximity to heat sources or in compartments with limited cooling or ventilation should consider to use SUPPO high temperature series cells.

Charge-temperature characteristics

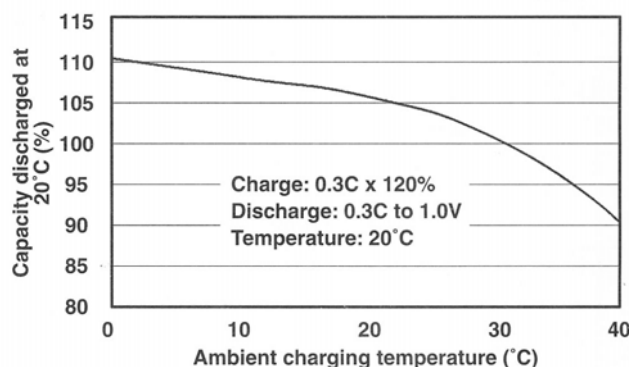

Figure 8

Charging Methods

Charge is the process of restoring a discharged battery to its original capacity. In order for a battery to be usable for a long period of time, it must be charged via the proper charge method. Various methods are used to charge rechargeable cells, but SUPPO recommends the charge methods described below to charge its nickel-metal hydride batteries.

(1)Rapid charge current: 1CmA (rapid charge temperature range: 0°C to 40°C). In order to exercise proper control to stop rapid charge, it is recommended that batteries be charged at over 0.5CmA but less than 1CmA. Charging batteries at a current in excess of 1CmA may cause the safety vent to be activated by a rise in the internal pressure of the batteries, thereby resulting in electrolyte leakage. When the temperature of the batteries is detected by a thermistor or other type of sensor, and their temperature is under 0°C or over 40°C at the commencement of the charge, then trickle charge, rather than rapid charge, must be performed. Rapid charge is stopped when any one of the values among the types of control described in (4), (5), (6), and (11) reaches the prescribed level.

(2)Allowing a high current to flow to excessively discharged or deep-discharged batteries during charge may make it impossible to sufficiently restore the capacity of the batteries. To charge excessively discharged or deep-discharged batteries, first allow a trickle current to flow, and then proceed with the rapid charge current once the battery voltage has risen.

(3)Rapid charge start voltage: Approx. 0.8V/cell Rapid charge transition voltage restoration current: 0.2 ~ 0.3 CmA

(4)Upper battery voltage limit control: Approx. 1.8V/cell. The charge method is switched over to trickle if the battery voltage reaches approximately 1.8V/cell due to trouble or malfunctioning of some kind.

(5) $-\Delta V$ value: 5 to 10mV/cell. When the battery voltage drops from its peak to 5 to 10mV/cell during rapid charge, rapid charge is stopped, and the charge method is switched over to trickle charge.

(6)dT/dt value: Approx. 0.8-1°C/min. When a rise in the battery temperature per unit time is detected by a thermistor or other type of temperature sensor during rapid charge, rapid charge is stopped and the charge method is switched over to trickle charge.

(7)TCO: 48°C (for D, 2/3M, F and M sizes), 50°C (for AAAA, AAA, AA, A, SC, B series). The cycle life and other characteristics of batteries are impaired if the batteries are allowed to become too hot during charge. In order to safeguard against this, rapid charge is stopped and the charge method is switched over to trickle charge when the battery temperature has reached the prescribed level.

(8)Initial delay timer: 10 min. This prevents the -V detection circuit from being activated for a specific period of time after rapid charge has commenced. However, the dT/dt detection circuit is allowed to be activated during this time. As with Ni-Cd batteries, the charge voltage of nickel-metal hydride batteries may show signs of swinging (pseudo -V) when they have been kept standing for a long time or when they have discharged excessively, etc. The initial delay timer is needed to prevent charge from stopping (to prevent malfunctioning) due to this pseudo -V.

(9)Trickle current: 0.03 to 0.05CmA. When the trickle current is set higher, the temperature rise of the batteries is increased, causing the battery characteristics to deteriorate.

(10) Rapid charge transfer timer: 60 min.

(11) Rapid charge protection timer: 90 min. (at 1C charge)

(12) Total timer: 10 to 20 hours.

The overcharging of nickel-metal hydride batteries, even by trickle charging, causes a deterioration in the characteristics of the batteries. To prevent overcharging by trickle charging or any other charging method, the provision of a timer to regulate the total charging time is recommended.

Note: The temperature and voltage of nickel-metal hydride batteries varies depending on the shape of the battery pack, the number of cells, the arrangement of the cells and other factors. Therefore SUPPO should be consulted for more detailed information on the referenced charge control values.

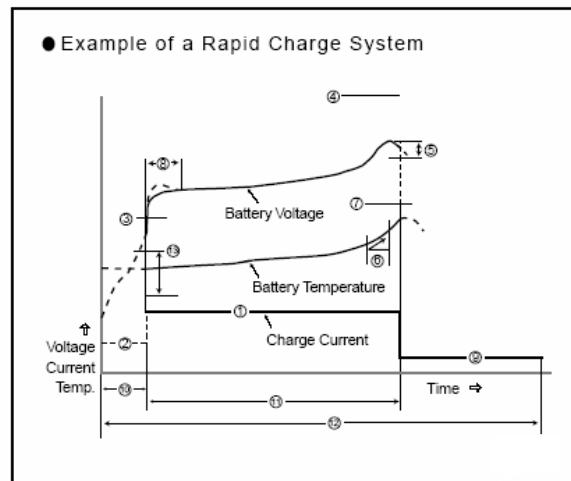

Figure 9

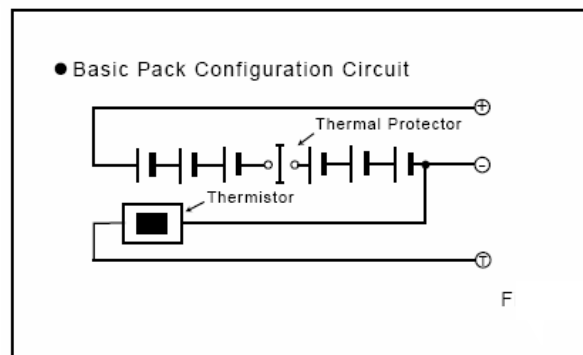

Figure 10

Storage Characteristics

Essentially all rechargeable battery cells gradually discharge over time whether they are used or not. This capacity loss is typically due to slow parasitic reactions occurring within the cell. As such, the loss rate (self-discharge rate) is a function of the cell chemistry and the temperature environment experienced by the cell. Due to the temperature sensitivity of the self-discharge reaction, relatively small differences in storage temperature may result in large difficult or impossible to reverse.

Cell and battery storage issues of concern to most application designers relate either to the speed with which the cells lose their capacity after being charged or the ability of the cells to charge and discharge “normally” after storage for some period of time. In both situations, general guidelines developed for nickel-cadmium cells work acceptably for nickel-metal hydride cells.

Storage temperature

As already mentioned, the self-discharge reaction rate increases with higher temperatures. Prolonged storage of the battery material deteriorating faster; leakage performance will also deteriorate, resulting in a reduced battery lifetime. It is recommended that, for long storage, batteries should be kept at room temperature or below (0-30°C).

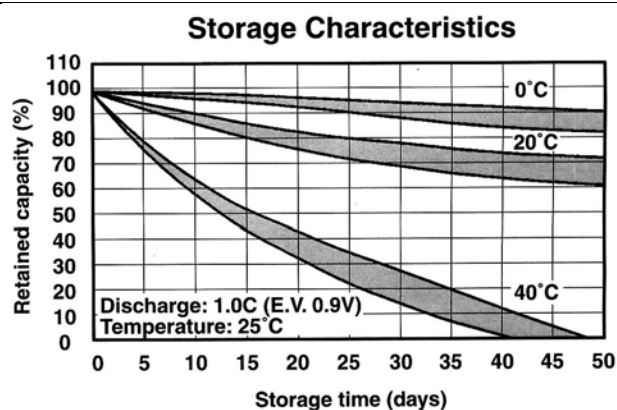

Figure 11

Storage time

As the battery loses energy during storage, the voltage also drops. In general, the battery capacity loss due to self-discharge during storage can be recovered by recharging. If the battery is stored for over six months, it is advisable to cycle the battery several times to resume the battery capacity. Use good inventory practices (first in, first out) to reduce time cells spend in storage.

Storage humidity

Leakage and rusting of metal parts are accelerated in high humidity environments, especially those with correspondingly high temperatures. The recommended humidity level for battery storage is a maximum of 60% RH.

Capacity Recovery after Storage

In normal practice, stored cells will provide full capacity on the first discharge after removal from storage and charging with standard methods. Cells stored for an extended period or at elevated temperatures may require more than one cycle to attain pre-storage capacities. Consultation with the manufacturer is recommended if prolonged storage and rapid restoration of capacity is requested.

Loaded Storage

Cells and batteries intended for storage for extended periods of time (past the point where they are fully discharged) should be removed from their load. In particular, many portable electronic devices place a very low level drain requirement on their batteries even when in the "off" position. These micro-current loads may be sustaining volatile memory, powering sense circuits or even maintaining switch positions. Such loads should be eliminated when storing devices for protracted periods.

When nickel-metal hydride cells are stored under load, small quantities of electrolyte can ultimately begin to seep around the seals or through the vent. This creep leakage may result in the formation of crystals of potassium carbonate, which detract cosmetically from the appearance of the cell. In extreme cases, creep leakage can result in corrosion of cells, batteries, or the adjoining compartment. Although such occurrences are rare, positive methods of electrically isolating the cell, such as an

insulating tape over the positive terminal or removal from the product, are suggested for applications requiring extended storage of cells.

Cycle life

A key determinant of the economic and practical feasibility of using nickel-metal hydride batteries in portable electronic applications is the cell's cycle life: the ability to deliver acceptable capacity on a repetitive basis, evaluated as the number of charges and discharges cycles before the discharge capacity drops to 80% of the nominal capacity.

Ambient temperature

It is recommended to cycle the battery at room temperature. At higher temperatures, the electrodes as well as the separator material deteriorate much faster, thus shortening the cycle life. At lower temperatures, the rate of oxygen recombination during overcharge is slow, and may risk opening the vent leading to pre-mature electrolyte dry-out.

Overcharge

The cycle life of the battery is sensitive to the amount of overcharge at high charge rate. The amount of overcharge affected cell temperature and oxygen pressure inside the battery. Both factors deteriorate the metal-hydride electrode through oxidation and thus the cycle life shortens. For that reason the cycle life is affected by various charge cut-off methods as illustrated in the graph.

Deep discharge

The cycle life is also affected by the depth of discharge: the number of charge/discharge cycles will decrease if the battery is repeatedly subject to deep discharging below 1V, or to a status of polarity reversal. Considerably more cycle numbers can be obtained if the battery is cycled under shallower cycling conditions.

Application Design

Incorporation of nickel-metal hydride cells into applications is generally straightforward, particularly for designers accustomed to designing with nickel-metal cells. Primary differences between the two cell chemistries are:

- nickel-metal hydride cells offer higher energy densities.
 - environmental and occupational health issues relating to cadmium are eliminated with nickel-metal hydride cells.
 - More care is required in design of nickel-metal hydride charging systems.
 - Since nickel-metal hydride cells may emit hydrogen I heavy overcharge or overdischarge, both charge-control redundancy and location of the battery package in the product deserve careful scrutiny.
-

Orientation

Nickel-metal hydride cells will operate satisfactorily in any orientation

Temperature

Like most other battery cells, nickel-metal hydride cells are most comfortably applied in a near-room –temperature environment (10-30°C); however, with careful attention to design parameters, they can be successfully utilized when exposed to a much wider range of temperatures. For operation at over 40°C or below 0°C, please select the specific series of batteries and contact SUPPO for any further design guide.

Ventilation and Isolation

The primary gas emitted from the nickel-metal hydride cell when subjected to excessive overcharge is hydrogen gas opposed to oxygen for the nickel-cadmium cell. Although venting of gas to the outside environment should not occur in a properly designed application, isolation of the battery compartment from other electronics (especially mechanical switches that might generate sparks) and provision of adequate ventilation to the compartment are required to eliminate concerns regarding possible hydrogen ignition.

Isolation of the battery from heat-generating componetry and ventilation around the battery will also reduce thermal stress on the battery and ease design of appropriate charging systems.

Battery Assembly

Nickel-metal hydride batteries are generally packaged in two forms:

Hard plastic cases are recommended for applications requiring the end-user to handle the battery. These cases offer greater protection against handling damage and shock and vibration stresses. But, depending on the design, thermal management may be more difficult within the hard case. The temperature of NiMH cells rises when the charge gets close to completion. Temperature increase is greater for a battery pack than for a single cell, due to the fact that the pack does not really allow for the dissipation of heat. The problem is further exacerbated when the pack is enclosed in a plastic case. Air ventilation should be provided in the plastic case of batteries—to allow for egress of any gasses that may result from activation of the safety vent of cells after abuse. Air tight battery compartments are strongly discouraged.

Lighter shrink-wrapped plastic packaging may be used when routine battery removal is not expected. These packs usually consist of the cell assembly with insulators covering the exposed terminals. Plastic shrink tubing then covers the whole pack. Shrink-wrapped batteries have acceptable mechanical integrity for assembly and, when properly secured, withstand normal portable-product shock and vibration levels. The resistances spot-welding method is to be used when NiMH cells are connected in a series, or in parallel formation, to avoid an excessive increase in cell temperature, which would occur if soldered on directly. Leads used for cell connections should be nickel-plated or pure Nickel, measuring 0.1mm to 0.2mm in thickness and 3mm to 6mm in width.

Thermal Protection for Battery Packs

Battery packs intended for fast charging methods should have a thermal protection device. A thermistor sensing the temperature inside the pack should be employed. It is also desirable to have a thermostat/polyswitch and a temperature fuse installed in the battery pack to protect it from abnormal rises in temperature and external short-circuiting. Thermostats which operate around 75°C and temperature fuses rated to 100°C are recommended. Locations for safety devices in battery pack assembly are shown in the following diagrams.

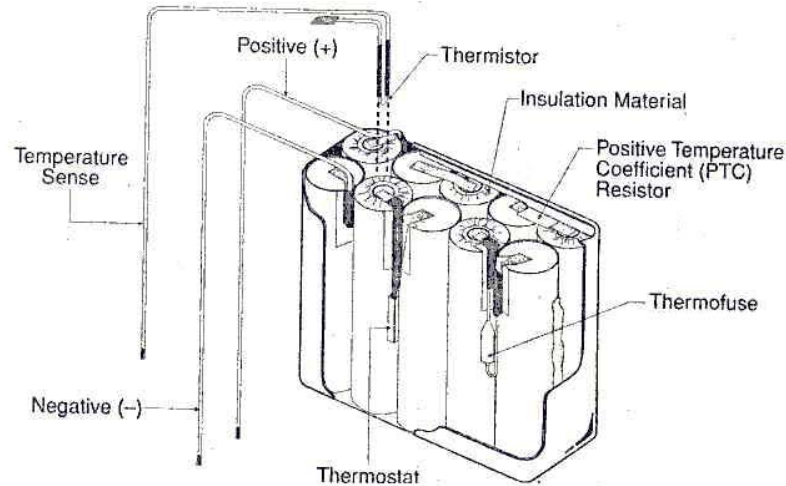

Figure 12

Proper Use and handling

Nickel-metal hydride cells should be handled in much the same manner as nickel-cadmium cells. Major points are summarized below. Contact the cell manufacturer for additional information pertinent to specific applications.

General Safety Precautions

Nickel-metal hydride cells are generally well-behaved; however, like any rechargeable cell, they should be treated with care. Issues in dealing with nickel-metal hydride cells include the following:

- Nickel-metal hydride cells operate on an exothermic, hydrogen-based charging and oxygen recombination process. Precautions should be taken to avoid venting. Should venting occur, the vent gases must be properly managed.
- Nickel-metal hydride cells can generate high currents if shorted. These currents are sufficient to cause burns or ignition of flammable materials.
- The active materials in the negative electrode can ignite on exposure to air. The electrolyte is corrosive. For these reasons, the cell should be maintained intact and sealed.

Shipping and Handling

Shipping and handling of nickel-metal hydride cells is straightforward. The following suggestions ensure maximum performance, reliability, and safety in

working with the cells:

- Ship cells only in the fully discharged state.
- Provide proper packaging, considering the cell's and batteries' weight, to avoid transit damage, either to cells or adjacent items.
- Do not store cells or batteries in loaded or shorted condition.
- Use product on a first-in, first-out inventory management policy.
- Avoid excessive handling of charged cells batteries outside the end-use product.

Disposal

Although disposal procedures for nickel-metal hydride cells are still evolving, as a minimum, observe the following precautions:

- Discharge fully prior to disposal.
- Do not incinerate
- Do not open or puncture the cells.
- Observe all national, state, and local rules and regulations for disposal of rechargeable cells

Incoming Inspection

Normal incoming inspection techniques consist of physical examination of the cells for any dents, bulges, or leakage and selection of a representative sample for capacity testing, it is normal if the initial capacity is lower than nominated, charge and discharge for several times will restore the full capacity. In general 100 percent capacity testing is discouraged because of the cost/schedule impact. Specialized incoming test procedures are normally developed for each application by consultation between the product designer and the cell manufacturer.

Charging/discharging/storage temperature

It is important to understand how ambient temperature affects the charging and discharging of batteries, especially for obtaining maximum efficiency in conditions that exceed room temperature. SUPPO recommends the following temperature range.

Standard, high drain and high capacity series—cylindrical/prismatic/9V

Standard charge: 0°C to 45°C

Fast charge: 10°C to 45°C

Discharge: -20°C to 50°C

Storage: -20°C to 35°C

High temperature series—cylindrical

Standard charge: 0°C to 70°C

Discharge: -20°C to 70°C

Storage: -20°C to 70°C

Button cell

Charge/discharge: 0°C to 45°C

Storage: -20°C to 45°C

Using or storing the battery beyond the recommended temperature range leads to deterioration in performance. For example: leakage, shortening of battery life, and

lowing of charging efficiency may occur at higher temperatures.

At sub-zero temperatures, non-low temperature battery discharge capacity will decrease due to lower mobility of the ions inside the battery.

Handling Precaution:

- Do not place the batteries close to heat sources, never immerse the batteries in water nor expose them to fire, doing so may cause leakage of battery fluid, heat generation, bursting and fire.
- Never short circuit the battery, do not try to rip off the sleeve and insulator during transportation or usage, doing so will expose the battery to the risk of a short circuit and may cause leakage of battery fluid, heat generation, bursting and fire.
- Never carry a battery with other metallic belongings to avoid short-circuiting.
- Make sure terminals are correctly positioned in the equipment, if the terminals are reversed, during charging the battery may be discharged rather than charged. Furthermore, reversed connections may cause abnormal chemical reaction in the battery fluid, heat generation, bursting and fire.
- Never disassemble SUPPO batteries. Doing so may cause internal or external short circuit or result in exposed active materials of battery reacting chemically with the air. It may also cause heat generation, bursting and fire. Also, this is dangerous as it may cause splashing of alkaline fluid.
- Never modify or reconstruct SUPPO batteries. Protective devices to prevent danger are normally built in the batteries. If these are damaged, excessive current flow may cause loss of control during charging or discharging of the battery, leakage of battery fluid, heat generation, bursting or fire.
- Never solder any lead wires directly to the batteries, spot weld is strongly recommended. When SUPPO batteries are to be incorporated in equipment or housed within a case, avoid air-tight structures as this may lead to the equipment or case being damaged or may be harmful to user.
- Do not connect batteries for more than 20 cells in series, as this may cause electric shocks, leakage of battery fluid and heat generation, if this is a must, please consult SUPPO.
- Paralleled connection is generally not recommended, please consult SUPPO for possible exceptions to connecting the batteries in parallel charging.
- Keep the batteries away from strong vibration and high impact.
- We recommend to keep the batteries in well ventilated dry places at room temperature of 10-30°C and relative humidity <60%, keep the batteries away from dust contamination and chemical corrosion.
- Keep the batteries or equipment out of the reach of babies and small children.
- Charge the batteries with only specified charger or With specified charge procedure, do not overcharge SUPPO batteries by exceeding the predetermined charging period specified. Prolonged charging may cause leakage of battery fluid, heat generation, bursting and fire.
- Use the batteries within a temperature of -20-50°C, we recommend to use between 10°C-30°C to ensure best performance. Do not discharge more than 3CmA and lower than 1.0V/cell other than high drain series batteries. If there are special requirements on this, please contact SUPPO.
- Do not mix older and newer ones, different kind of batteries or batteries by other

manufacturers, due to varying electrical characteristics and capacity.

- Never leave a battery connected to a device for long periods without charging the battery, especially for devices that constantly drain standby current.

Battery Maintenance

Periodic visual inspection of the battery is recommended.

If the battery is stored for over six months, it is recommended to charge and discharge the battery several times to resume the battery capacity, failure to do so may result in a loss of capacity and shorter battery life.

Bear in mind that self-discharge has to be taken into consideration when storing a charged battery. The remaining battery capacity should be at least 50% after a month of storage at room temperature for a fully charged battery. High storage temperatures will accelerate the self-discharge, and reduce the remaining capacity.

MSDS(Material Safety Data Sheet) and Transportation

Material Safety Data Sheet (MSDS) are a sub-requirement of the Occupational Safety and Health Administration (OSHA) Hazard Communication Standard, 29 CFR Subpart 1910.1200. This Hazard Communication Standard does not apply to various subcategories including anything defined by OSHA as an “article”. OSHA has defined “article” as a manufactured item other than a fluid or particle; i) which is formed to a specific shape or design during manufacture; ii) which has end use function(s) dependent in whole or in part upon its shape or design during end use; and iii) which under normal conditions of use does not release more than very small quantities, e.g. minute or trace amounts of a hazardous chemical, and does not pose a physical hazard or health risk to employees.

Because all of SUPPO batteries are defined as “articles” they are exempt from the requirements of the Hazard Communication Standard, hence a MSDS is not required. Enclosed MSDS is provided as a service to our customers only.

SUPPO sealed nickel metal hydride batteries are considered to be “dry cell” batteries and are unregulated for purposes of transportation by the U.S. Department of Transportation(DOT), international Civil Aviation Administration(ICAO), international Air Transport Association (IATA) and the international Maritime Organization (IMO). The only requirements for shipping these batteries by DOT is Special Provision 130 which states: “Batteries, dry are not subject to the requirements of this subchapter only when they are offered for transportation in a manner that prevents the dangerous evolution for heat(for example, by the effective insulation of exposed terminals) The only requirements for shipping these batteries by ICAO and IATA is Special Provision A123 which states: “An electrical battery or battery powered device having the potential of dangerous evolutions of heat that is not prepared so as to prevent a short-circuit(e.g. in the case of batteries, by the effective insulation of exposed terminals; or in the case of equipment, by disconnection of the battery and protection of exposed terminals) is forbidden from transportation.