

Parameters

Nominal Voltage		1.2 V
Nominal capacity (0.2C)		5000 mAh
Min. capacity		4800 mAh
Dimension	OD(mm)	25.8 (+0/-0.5)
	Height(mm)	Max 50.0
Weight (g)		Max 90
Impedance(1000Hz)		Max 10 mΩ
Charge	Standard Charge	500 mA×16hrs
	Rapid Charge	2000 mA×160mins
	(need control)	
Ambient Temperature	Charge	Standard charge: 0-40 Deg. Rapid Charge: 10-35 Deg.
	Discharge	-20-55 Deg.
Storage	12 months:	-20-35 Deg.
	3 months:	-20-45 Deg.
	1 month:	-20-55 Deg.

Charge characteristics

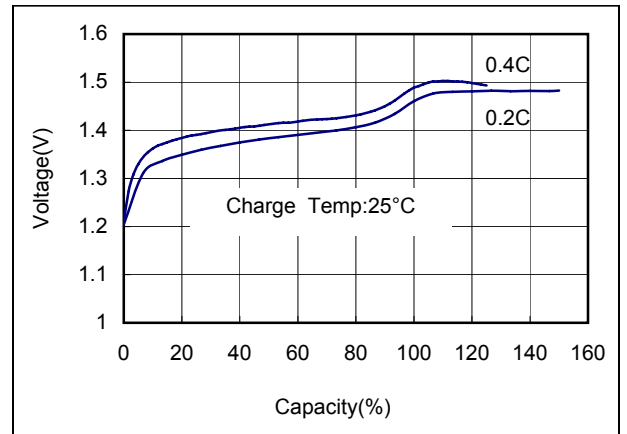
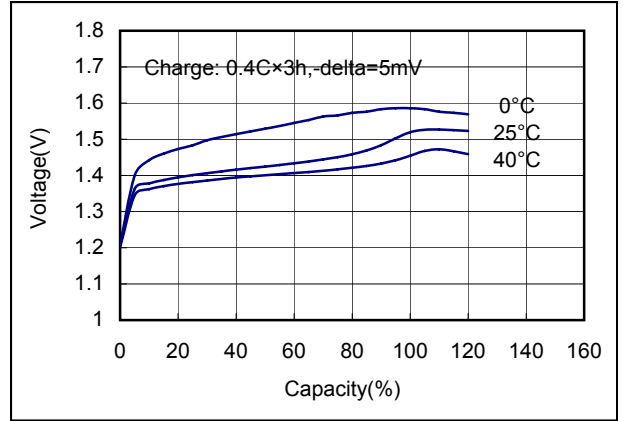

Dimension(with tube)mm

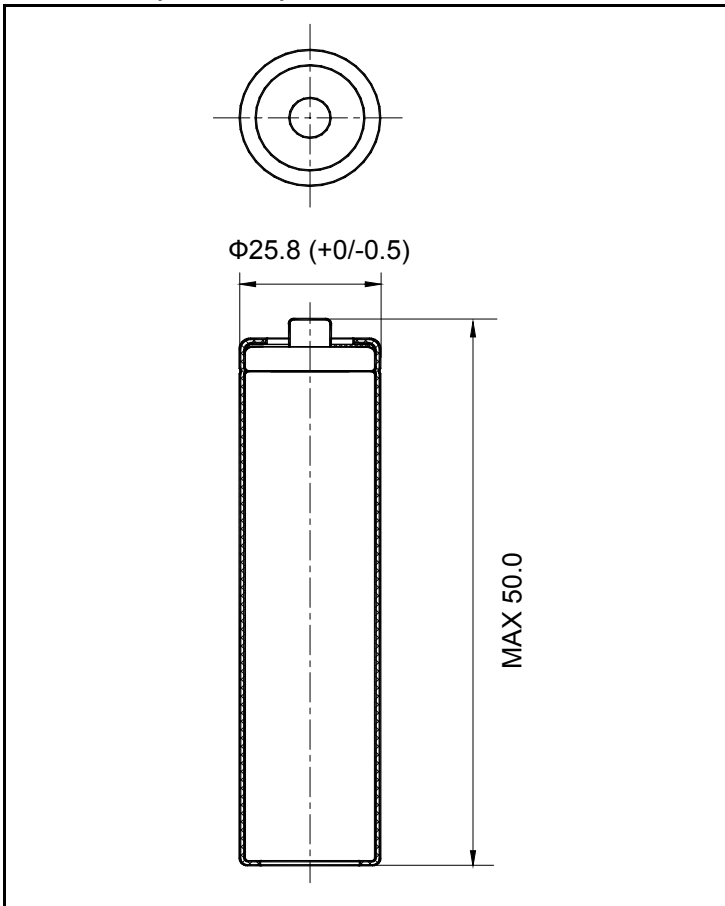

Discharge characteristics

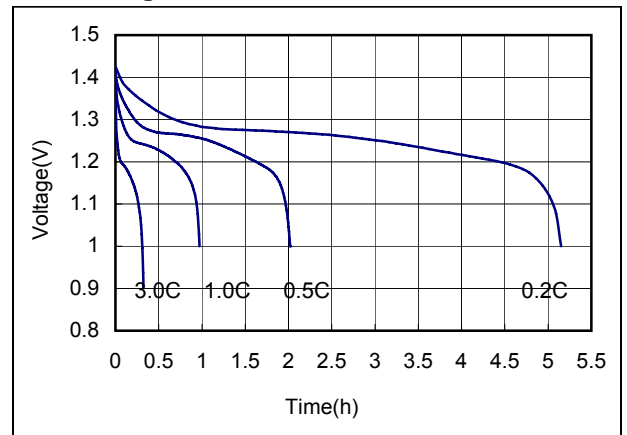

Self discharge characteristics

