

Parameters

Nominal Voltage		1.2 V
Nominal capacity (0.2C)		1800 mAh
Min. capacity		1700 mAh
Dimension	OD(mm)	14.5 (+0/-0.5)
	Height(mm)	Max 50.5
Weight (g)		Max 27.5
Impedance(1000Hz)		Max 35 mΩ
Charge	Standard Charge	180 mA×16hrs
	Rapid Charge	1800 mA×63mins
	(need control)	
Ambient Temperature	Charge	Standard charge: 0-40 Deg. Rapid Charge: 10-35 Deg.
	Discharge	-20-55 Deg.
Storage	12 months:	-20-35 Deg.
	3 months:	-20-45 Deg.
	1 month:	-20-55 Deg.

Charge characteristics

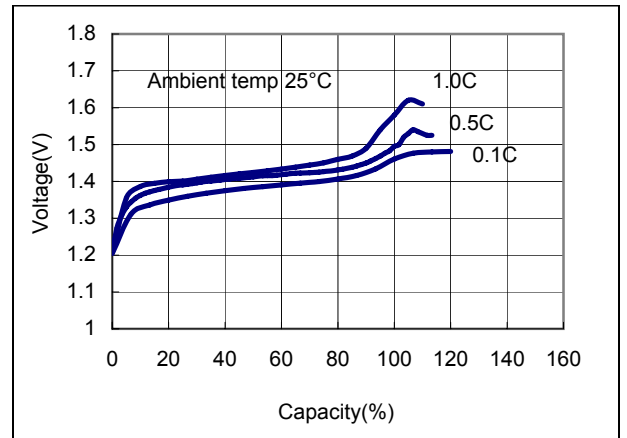
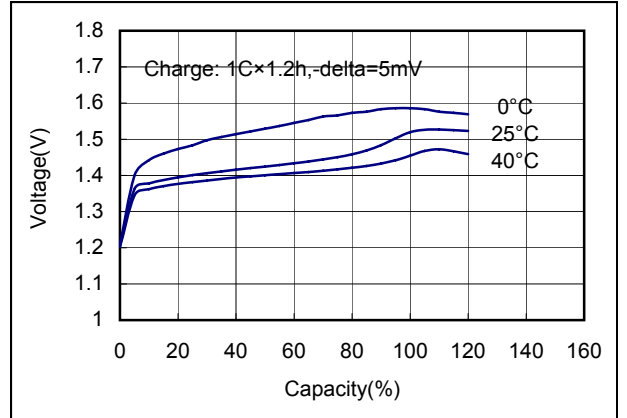

Dimension(with tube)mm

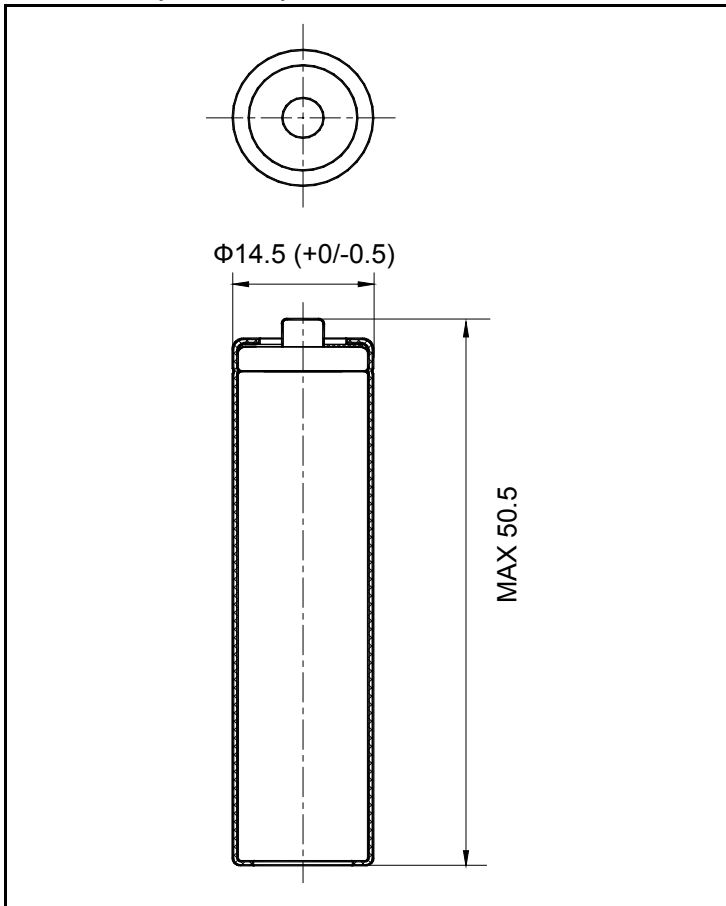

Discharge characteristics

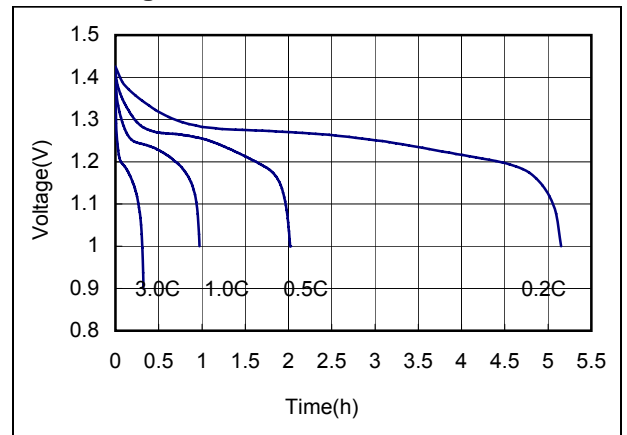

Self discharge characteristics

