

Parameters

Nominal Voltage		1.2 V
Nominal capacity (0.2C)		650 mAh
Min. capacity		600 mAh
Dimension	OD(mm)	10.5 (+0/-0.5)
	Height(mm)	Max 44.5
Weight (g)		Max 12.5
Impedance(1000Hz)		Max 40 mΩ
Charge	Standard Charge	65 mA×16hrs
	Rapid Charge	650 mA×63mins
	(need control)	
Ambient Temperature	Charge	Standard charge: 0-40 Deg. Rapid Charge: 10-35 Deg.
	Discharge	-20-55 Deg.
Storage		12 months: -20-35 Deg.
		3 months: -20-45 Deg.
		1 month: -20-55 Deg.

Charge characteristics

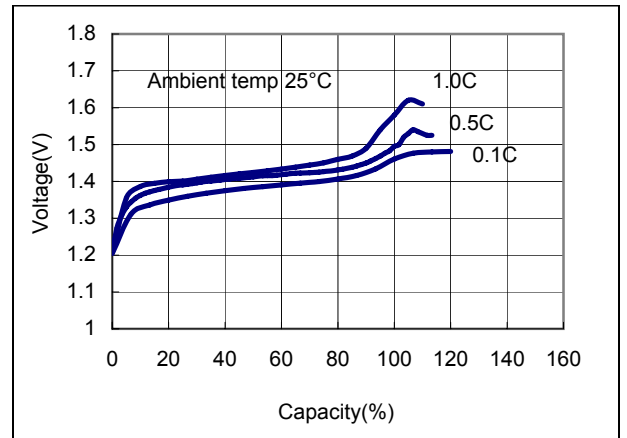
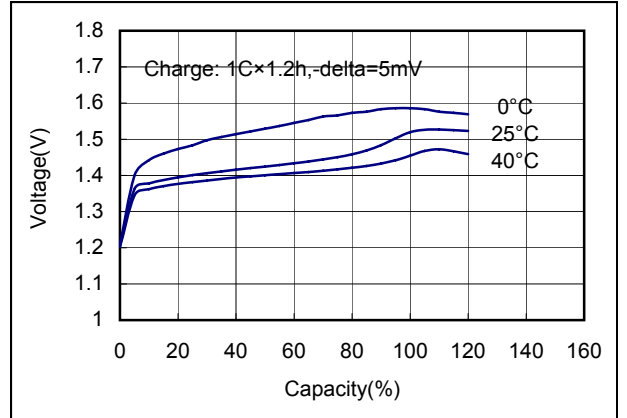

Dimension(with tube)mm

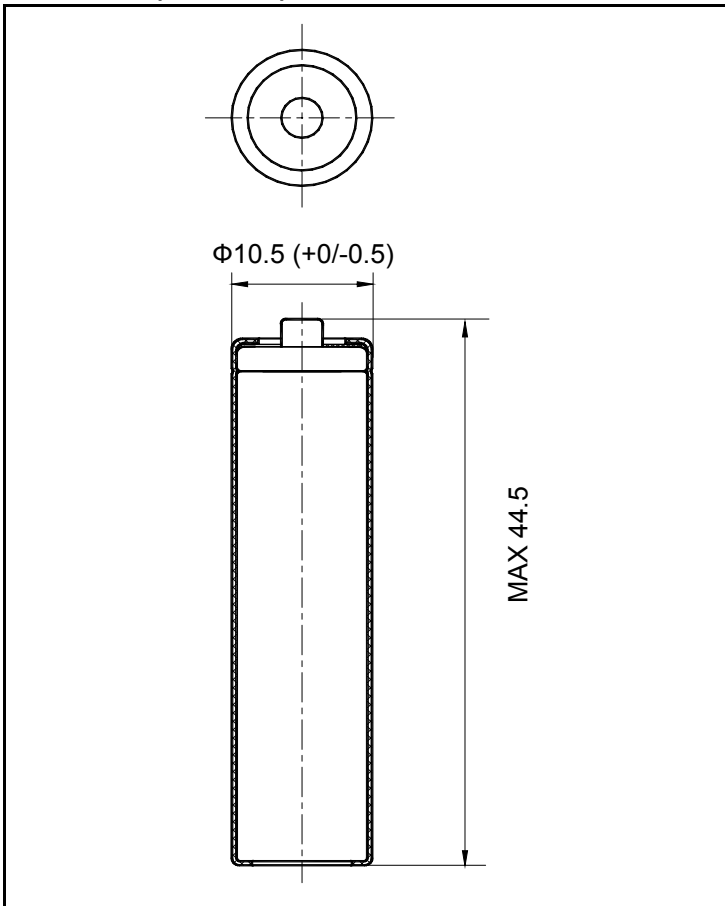

Discharge characteristics

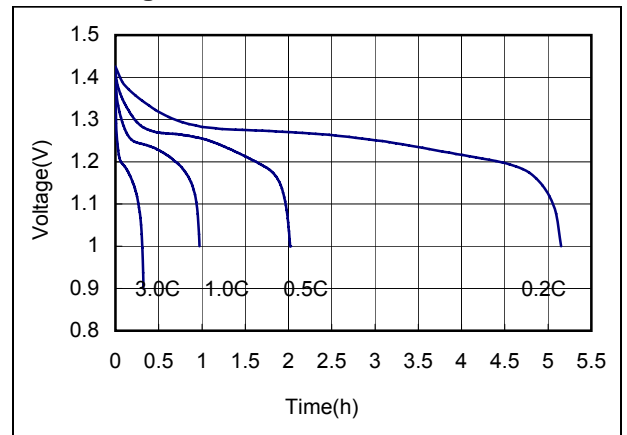

Self discharge characteristics

